

SX 290 TRIANGULAIRE

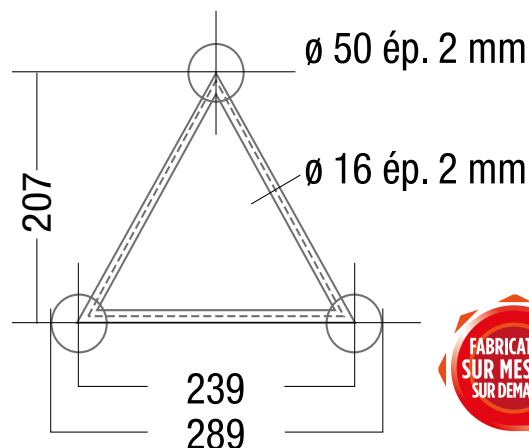

CHARGES MAXIMALES (1/100)*
POINTE EN HAUT



Portée (m)	Flèche (mm)	Q	P1	P2 P2	P3 P3 P3	P4 P4 P4 P4	SW (kg)
		(kg/ml)	(kg)	(kg/pt2)	(kg/pt3)	(kg/pt4)	
1	10	1338	1338	669	446	335	4
2	20	667	1335	667	445	334	8
3	30	444	1092	665	444	333	11
4	40	332	813	613	409	332	15
5	50	261	643	487	325	271	19
6	60	180	529	403	268	224	23
7	70	131	446	342	228	190	27
8	80	100	384	295	197	165	30
9	90	71	334	228	165	130	34
10	100	50	293	180	130	102	38
11	110	37	238	143	104	82	42
12	120	28	190	115	84	66	46
13	130	21	151	93	68	54	49
14	140	16	120	75	55	44	53
15	150	12	94	60	44	36	57
16	160	9	71	47	35	29	61
17	170	7	53	36	28	23	65
18	180	5	36	27	21	17	68
19	190	4	22	19	15	13	72
20	200	3	9	12	10	9	76

CHARGES PRÉCONISÉES (1/300)*
POINTE EN HAUT



Portée (m)	Flèche (mm)	Q	P1	P2 P2	P3 P3 P3	P4 P4 P4 P4	SW (kg)
		(kg/ml)	(kg)	(kg/pt2)	(kg/pt3)	(kg/pt4)	
1	3	1338	1338	669	446	335	4
2	7	667	1335	667	445	334	8
3	10	444	1092	665	444	333	11
4	13	278	690	407	292	230	15
5	17	141	433	256	184	145	19
6	20	80	291	173	124	98	23
7	23	49	204	122	88	70	27
8	27	31	146	88	64	51	30
9	30	21	105	65	47	38	34
10	33	14	75	47	35	28	38
11	37	10	51	34	25	20	42
12	40	7	33	23	18	15	46
13	43	4	17	15	12	10	49
14	47	3	4	7	7	6	53
15	50	2	N.A	1	2	2	57
16	53	1	N.A	N.A	N.A	N.A	61
17	57	N.A	N.A	N.A	N.A	N.A	65
18	60	N.A	N.A	N.A	N.A	N.A	68
19	63	N.A	N.A	N.A	N.A	N.A	72
20	67	N.A	N.A	N.A	N.A	N.A	76

Sous réserve que l'utilisateur ait vérifié au préalable la stabilité au non-basculement de la poutre

*Bien comprendre les taux de flèche, se reporter à l'introduction

SX 290 TRIANGULAIRE

CHARGES MAXIMALES (1/100)*



POINTE EN BAS

Portée (m)	Flèche (mm)	Q	P1	P2 P2	P3 P3 P3	P4 P4 P4	SW (kg)
		(kg/ml)	(kg)	(kg/pt2)	(kg/pt3)	(kg/pt4)	
1	10	1338	1338	669	446	335	4
2	20	667	820	617	411	334	8
3	30	364	541	408	272	227	11
4	40	203	399	303	202	169	15
5	50	129	312	239	159	133	19
6	60	88	253	196	130	109	23
7	70	64	210	164	109	92	27
8	80	48	177	140	93	79	30
9	90	37	150	121	81	68	34
10	100	29	128	105	70	59	38
11	110	24	109	92	61	52	42
12	120	19	92	81	54	46	46
13	130	16	78	71	47	41	49
14	140	13	65	62	41	36	53
15	150	11	53	54	36	32	57
16	160	9	43	47	31	28	61
17	170	7	33	36	27	23	65
18	180	5	24	27	21	17	68
19	190	4	15	19	15	13	72
20	200	3	7	12	10	9	76

CHARGES PRÉCONISÉES (1/300)*



POINTE EN BAS

Portée (m)	Flèche (mm)	Q	P1	P2 P2	P3 P3 P3	P4 P4 P4	SW (kg)
		(kg/ml)	(kg)	(kg/pt2)	(kg/pt3)	(kg/pt4)	
1	3	1338	1338	669	446	335	4
2	7	667	820	617	411	334	8
3	10	364	541	408	272	227	11
4	13	203	399	303	202	169	15
5	17	129	312	239	159	133	19
6	20	80	253	173	124	98	23
7	23	49	204	122	88	70	27
8	27	31	146	88	64	51	30
9	30	21	105	65	47	38	34
10	33	14	75	47	35	28	38
11	37	10	51	34	25	20	42
12	40	7	33	23	18	15	46
13	43	4	17	15	12	10	49
14	47	3	4	7	7	6	53
15	50	2	N.A	1	2	2	57
16	53	1	N.A	N.A	N.A	N.A	61
17	57	N.A	N.A	N.A	N.A	N.A	65
18	60	N.A	N.A	N.A	N.A	N.A	68
19	63	N.A	N.A	N.A	N.A	N.A	72
20	67	N.A	N.A	N.A	N.A	N.A	76

Sous réserve que l'utilisateur ait vérifié au préalable la stabilité au non-basculement de la poutre

*Bien comprendre les taux de flèche, se reporter à l'introduction

POUTRES LIVRÉES SANS KIT



LONGUEUR (m)	0,25	0,29	0,50	0,71	0,742	1,00	1,50	2,00	2,50	3,00	3,50	4,00
POIDS (kg)	2	2	2,7	3,45	3,5	4,3	5,9	7,45	9,1	10,5	13	14,5
RÉFÉRENCE	SX29025	SX29029	SX29050	SX29071	SX290745	SX29100	SX29150	SX29200	SX29250	SX29300	SX29350	SX29400

CERCLES LIVRÉS AVEC KITS



Préciser le sens de la pointe :



PH
Pointe en haut



PI
Pointe vers l'intérieur





PE
Pointe vers l'extérieur

Ø EXTÉRIEUR (m)	2,00	2,50	3,00	4,00	4,50	5,00	6,00	7,00	8,00	12,00	14,00
NBRE ÉLÉMENTS	2	2	4	4	6	6	6	8	8	12	14
RÉFÉRENCE	SXC29200	SXC29250	SXC29300	SXC29400	SXC290450	SXC29500	SXC29600	SXC29700	SXC29800	SXC291200	SXC291400

SX 290 TRIANGULAIRE

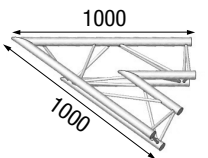
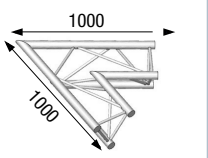
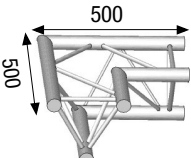
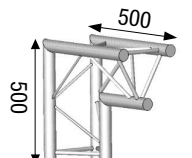
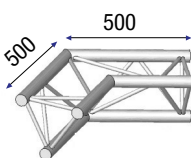
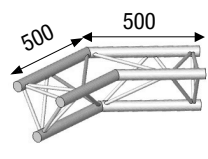
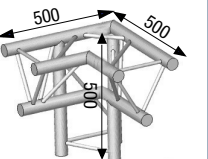
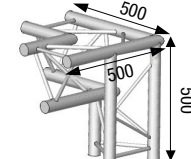
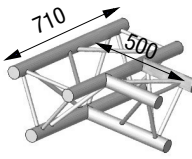
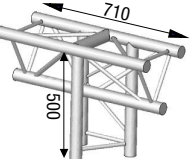
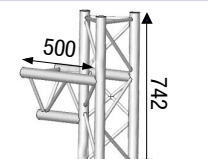
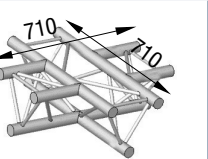
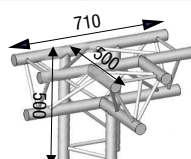
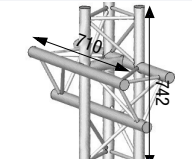
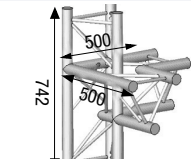
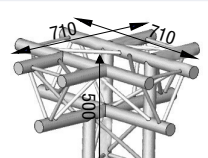
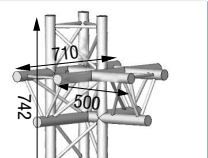
ANGLES LIVRÉS SANS KIT

ASX 20 6 kg - 45° 	ASX 21 6 kg - 60° 	ASX 22 3,5 kg - 90° 	ASX 23 3,8 kg - 90° 	ASX 24 4 kg - 120° 
ASX 25 4 kg - 135° 	ASX 31 5 kg - 90° 	ASX 32 5 kg - 90° 	ASX 33 5,7 kg - 90° 	ASX 34 5,7 kg - 90° 
ASX 35 5,7 kg - 90° 	ASX 41 6,2 kg - 90° 	ASX 42 6,3 kg - 90° 	ASX 44 6,3 kg - 90° 	ASX 45D/G 6,3 kg - 90° 
ASX 51 7,8 kg - 90° 	ASX 52 7,9 kg - 90° 	ASX 61 9 kg - 90° 		

SX 290 TRIANGULAIRE

